



Instruction manual

5GH65BB390

5GH65BB490

5GH75BB390

5GH75BB490

5GH85BB390

5GH85BB490

5GH85BB590

Enjoy it.

Gas-Hobs

For Your Safety

These instructions have been drawn up for your safety and that of others. You are therefore requested to read them carefully before installing and using the appliance. Keep this instruction manual for future reference as necessary. If the appliance is sold **or** moved, make sure that the manual is handed over to the new user.

Installation

- Installation of the appliance and its connection to the electrical mains must only be carried out by **QUALIFIED PERSONEL**. Before any procedure, it is important to check that the appliance is **DISCONNECTED** from the electrical mails.
- It is risky to modify or attempt to modify the characteristics of this product.
- After removing the appliance from the packaging, make sure that it is undamaged and that the electrical lead is in perfect condition. Otherwise, contact your dealer before putting the appliance into operation.
- The Manufacturer declines all responsibility in case of failure to comply with the accident prevention regulations.
- Make sure that air is able to circulate freely around the appliance. Poor ventilation produced a shortage of oxygen
- Make sure that the appliance is supplied with the type of gas indicated on the relative sticker next to the mains gas connection pipe.
- Use of a gas cooking appliance produces heat and moisture in the room in which it is installed. Ensure that the room is well ventilated by keeping the air intakes open and in good working order or by installing an extractor hood with discharge pipe.
- If the appliance is used intensively for a long time the effectiveness of the ventilation will have to be increased, for example by opening a window or increasing the power of any electric extractor fan.

During use

- This product is designed to cook **food** inside ordinary homes and for non-professional purposes. It should not be used for any other purpose.
- After using the appliance, make sure that all controls are in “CLOSED” or “OFF” position.
- If you use an electrical socket close to this appliance, take care that the cables of the appliances **you are using are far away** from the hot parts of this appliance.

Children's safety

- This appliance must only be used by adults. Make sure that children do not touch the controls or play with the appliance.
- The exposed parts of this appliance heat up during cooking and remain hot for some time even after it is switched off. Keep children well away until the appliance has cooled down.

Cleaning and maintenance

- Keep the appliance thoroughly cleaned. Food residues may cause fire risks.

Service and parts

- In the instance of malfunctions. Never attempt to repair the appliance yourself. Repairs by unskilled persons may cause damage and accidents. First refer to the contents of this manual. If you do not find the necessary information, contact your nearest Service Centre. Servicing work on this appliance must be carried out by an authorized Technical Service Centre. Always request the use of original spare parts.

Environmental protection advice

- All the materials used are environmentally compatible and recyclable. Please make your contribution to conserving the environment by using the separate waste collection channels available.

Decommissioned appliances

- Appliances which are no longer used or usable are not worthless waste. Through environment-friendly disposal, a number of materials used in the production of your appliance can be recovered.
 - Find out about the current disposal options from your specialist dealer, or your local authority.
- Before scrapping the appliances, cut the power supply lead and make it unusable.

Contents

For the User

For your safety.....	2
Description of the hob.....	4
Instructions for use	4
Cleaning and maintenance.....	6

For The Installation Technician

Technical data.....	8
Instructions for the installation technician.....	9
Electrical connection.....	11
Adapting to the different types of gas.....	12
Building into fitted kitchen units.....	13

Guide to reading the instructions

The following symbols will help you
When reading the instructions:



Safety information



“Step by step” instructions



Suggestions and Advice



Information concerning environmental protection



This appliance complies with the following EEC Directives:

- 73/23 and 90/683 (relating to Low Voltage);
- 89/336 (relating to Electromagnetic Compatibility);
- 90/396 (relating to Gas Appliances);
- 93/68 (relating to the General Standards)

And subsequent amendments.

Description of the hob

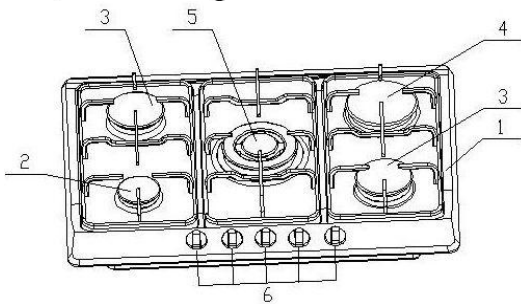



1. Hob
2. Small auxiliary burner
3. Medium semi-rapid burner
4. Large rapid burner
5. Triple flame burner
6. Burner control knobs
7. Hot plate
8. Indicator tight

1

Instructions for use

The hob control knobs

The symbols on the control knobs mean the following:

- no gas flow
-  maximum gas flow
-  Minimum gas flow

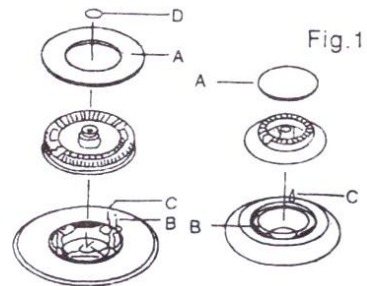

All operating positions must be set between the maximum and minimum flow settings, and never between the maximum setting and the closed position.

-  (Symbol present on version with lighting integrated in the Control knob)



- A-Burner cap
- B-Lighting plug
- C-Thermocouple
- D-Triple flame cap

Dual triple flame version

- no gas flow
-  maximum gas flow from central burner
-  minimum gas flow from central burner

-  maximum gas flow from outer and central burners simultaneously

-  minimum gas flow from outer and central burners simultaneously

Lighting the burners



To obtain a flame more easily, light the burner before placing a cooking utensil on the pan stand



To light a burner, proceed as follow: for Version with lighting integrated in the

control knob push the knob of the burner fully down and turn it anticlockwise

to the “maximum flow” setting symbol, or press the button if the appliance has individual lighting.

- After lighting the flame, keep the knob pressed for about 10 seconds: this time is necessary to heat up the “thermocouple”(Fig.1-C) and activate the safety valve, which would otherwise cut off the gas flow.



Then check that the flame is even and turn the control knob to adjust the flame as required

In the instance of a power cut, place a flame near the burner and proceed as already described.

If the flame does not light after a few attempts, check that the “burner cap” and “flame cap” are correctly positioned.

To turn off the flame, turn the control knob clockwise to the ● symbol.

Before removing pans from the burners, always lower or turn off the flame.

For correct use of the hob

For lower gas consumption and better efficiency: Use only **flat**-bottomed pans of dimensions suitable for the burners, as shown in the table on the right. Also, as soon as a liquid comes to the boil take care to turn the flame down to a level that will just keep it boiling.

Burner	minimum diameter	maximum diameter
Large(rapid)	180mm	220mm
Medium(semi-rapid)	120mm	200mm
Small(Auxiliary)	80mm	160mm
Triple Flame	220mm	260mm



During cooking processes involving fats or oils, watch your foods carefully because these substances may catch fire if brought to high temperatures.

Cleaning and maintenance

Before each operation, disconnect the appliance from the electrical mains and allow it to cool down.

General cleaning

Wash enameled parts with lukewarm water and detergent: do not use abrasive products which might damage them.

Wash the flame caps and burner caps often with boiling water and detergent, taking care to remove all deposits

The hob pan stands can also be washed in a dishwasher

For stubborn dirt, use ordinary non-abrasive detergents or specific commercial products. We strongly advise you not to use scouring pads. Steel wool or acids for cleaning.

Hob

Clean the hob regularly with a soft cloth wet with lukewarm water and a little liquid detergent. Do not use the following products:

- household detergents or bleaches;
- soaped scouring pads not suitable for non-stick utensils;
- steel wool scouring pads;
- stain removers for baths or sinks.

If the hob gets very dirty, use specific commercial products.

Ignition plug

Automatic burner ignition is provided (when installed) by a ceramic “plug” and a metal electrode (B in fig.1). Periodically clean these parts of the hob thoroughly. In addition, to avoid ignition difficulties, check that the cavities in the burner are not obstructed.

To remove deposits from the burner cavities, remove the cap and separate the two parts (see diagram on the right). After cleaning, put the two parts back together and return them correctly to their position. After washing, replace the hob pan stands, checking that they are correctly positioned.

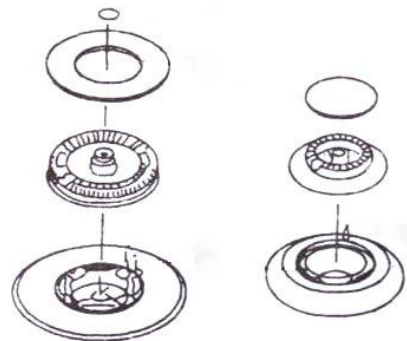

Routine maintenance

Have the condition and efficiency of the gas pipe and the pressure regulator (if installed) checked periodically. If anomalies are found, do not repairs but have the faulty part replaced.

To ensure good performance and safety, the gas regulator taps must be greased periodically.



Periodic lubrication of the taps must only be carried out by qualified **personel**, who must also be contacted if the appliance malfunctions.

Service and parts

Before leaving the factory, this appliance was tested and adjusted by specialist skilled staff to give the best operating results. Any subsequent necessary repairs or adjustments must be carried out with the greatest care and attention.

For this reason, we strongly advise you always to contact the Dealer who sold you the appliance or our nearest Service Centre, specifying the nature of the problem, the model of the equipment (Mod.), the product number (Prod. No.) and the serial number(Ser. No.). These data are provided in the plate on the cover of this manual. Always request the use of original spare parts.

Warranty conditions

You new appliance is covered by a warranty. The warranty conditions are provided in full in the “Warranty conditions-Service centers” leaflet which you will find inside the appliance

Keep the fiscal receipt or delivery note, either of which documents your purchase of the appliance and provides proof of date of purchase, in a safe place together with the leaflet.

If the After-Sales Service is call in, show these documents to the staff. If this procedure is not followed, the Service-Centre will have no option but to charge for any repairs.

If necessary, you may find your nearest Centre by consulting the” Warranty conditions –Service centers”.

Technical Data

BURNER TYPE	MAX OUTPUT	MIN OUTPUT	G30 28-30mbar	
	Kw	Kw	Nozzle Making mm	Cons g/h
Small Auxiliary burner	1.00	0.35	0.50	73
Medium Semi-rapid Burner	1.75	0.65	0.65	127
Large rapid burner	2.0	1.0	0.70	146
Triple flame burner	4.0	0.35	0.43 + 0.93	292

Gas intake connection

G1/2"

Electricity supply

220-240v~50/60Hz

Instructions for the installation technician



CAUTION: This appliance must only be installed and used in rooms with permanent ventilation to local standards.

Installation of the appliance and its connection to the electrical mains must only be carried out by **QUALIFIED PERSONEL**.

Before any procedure, it is important to check that the appliance is **DISCONNECTED** from the electrical mains. The Manufacturer declines all responsibility for any **damage arising** from installation in breach of the regulations in force or from failure to comply with the accident prevention regulations.

Installation premises

For proper operation of a gas appliance, the air necessary for the combustion of the gas must be able to flow into the room naturally. The air must flow into the room directly through openings in the outside walls. These openings must have an unobstructed cross-section **not** less than $2\text{m}^3/\text{h}$ for each kw of power (see total power in kw on the appliance nameplate).

This opening must be constructed so that it will not be obstructed from **inside or outside, or constructed close to the floor. The opening is recommended to be on the side opposite to that on which the flue gases are discharged.** If it is not feasible to provide these openings in the room where the appliance is installed, the necessary air may be taken from an adjacent room, provided that:

- this room is not a bedroom or a hazardous environment;
- this room **has ventilation**;
- the ventilation between the room where the appliance is installed and the adjacent **room has openings**.

Discharge of flue gases

Gas cooking appliances must discharge their flue gases through hoods connected directly to flues or the outdoors. If it is not possible to install the hood (fig. B) an electric fan must be installed on the outside wall or the window of the room, provided it is possible for the ventilation opening to be increased in proportion to the delivery rate of the fan (fig. C). For a kitchen, the delivery rate of this electric fan must guarantee an hourly air exchange of 3-5 times its volume. In both instances, the use of flues already used by other appliances to discharge the flue gases is forbidden.

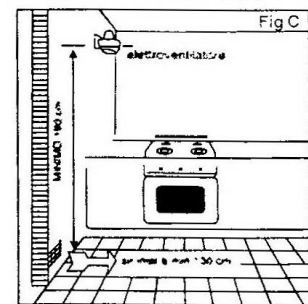
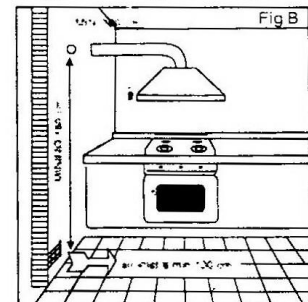
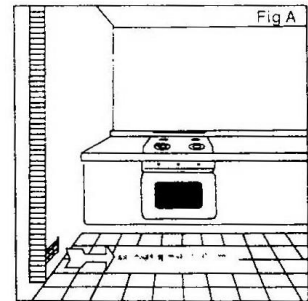

Connection to the gas supply

The gas Connection must be made in accordance with the local standards. When installing, fit a safety tap at the end of the pipeline. The appliance leaves the factory tested and set for the type of gas indicated on the plate inside the bottom guard, close to the gas connection pipe. Make sure that the type of gas to be supplied to the appliance is the same as that shown on the plate. Otherwise, follow the instructions provided in the “Adapting to different types of gas” section.

For maximum efficiency and minimum consumption, make sure that the gas supply pressure complies with the values shown in the gas used is different from that specified (or variable). a suitable pressure regulator must be installed on the supply pipeline.

The union must be fitted on the end of the gas train. Complete with GJ1/2 " threaded nut, fitting the gasket between the components as shown in the illustration. The gaskets must comply with the local standards. Screw the parts together without forcing, fit the union so that it points in the direction required then tighten all parts.

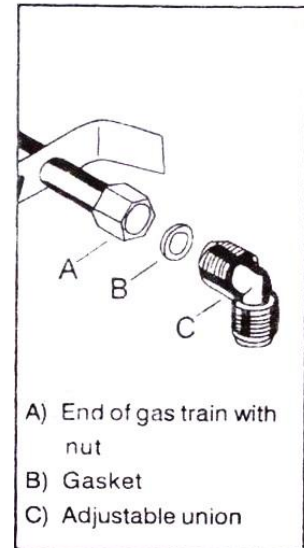

Connection

Make the connection to the gas system using a rigid metal pipe and regulation unions, or with a stainless steel hose complying with the local standard. If metal hoses are used, take care that they do not come into contact with mobile parts and are not crushed. This must also be checked if the hob is to be combined with an oven.

The gas intake connection of the appliance has a “ male thread.”

When making the connection, take care not to apply stresses of any kind to the appliance.



When the installation is complete, always check that all the unions are absolutely tight using a soapy solution. **Never use a flame to make this check.**

Electrical connection

The appliance is profited to operate with a power supply voltage of 230Vsingle-phase. The connection must be made in accordance with the regulations and laws in force.

Before making the connection, make sure that:

- 1) the safety circuit-breaker and the electrical system are able to withstand the load of the appliance(see nameplate).
- 2) The power supply system has an earth connection in good working order in accordance with the regulations in force;
- 3) The socket or omni polar switch use are easily accessible with the appliance installed.

Fit a plug suitable for the load on the power lead and connect it to a suitable safety socket.

If you wish to make a direct connection to the mains, an omni polar switch with a gap between the contacts of at least 3 mm, of suitable rating for the load and complying with the regulations in force, must be installed between the appliance and the mains. The switch must not break a contact in the yellow/green earth wire.

The brown live wire (connected to the “L” terminal of the terminal board) must always be connected to the live wire of the power supply mains.

In all cases, the power supply lead must be positioned so that it does not reach a temperature 50°C above the room temperature **at** any point.

One example of an ideal route is shown in the illustration. The cable is guided by means of band clamps fixed to the side of the cabinet, in order to avoid any contact with the appliance underneath the hob.

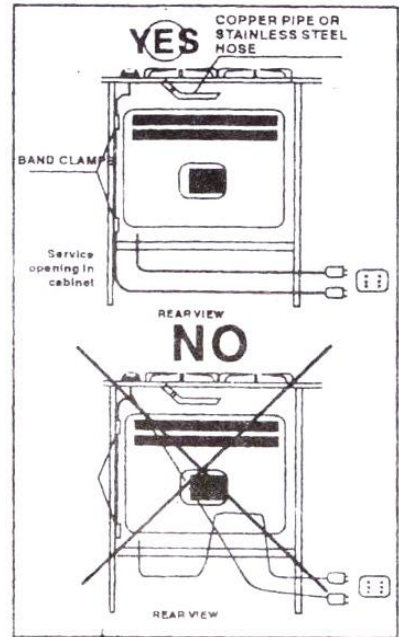

Replacing the power supply lead

If the lead has to be replaced, only HO5RR-F or HO5RN-F type cables suitable for the load and the operating temperature must be used. In addition, the yellow/green earth wire must be about 2 cm longer than the live and neutral wires.

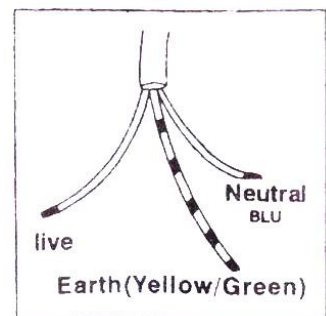

Adapting to the different types of gas

Changing the nozzles

- 1) Remove the pan standee.
- 2) Remove the burner caps and flame caps from the burners.
- 3) Use a size 7 socket wrench to unscrew and remove the nozzles, replacing them with those corresponding to the type of gas to be used (see the table).
- 4) Reassemble the parts, reversing the operations described above.
- 5) Then replace the setting data (close to the mains gas connection)with the one for the new type of gas If the pressure of the gas used is different from that specified(or variable),a suitable piped gas pressure regulator complying with the standard must be installed on the supply pipeline.

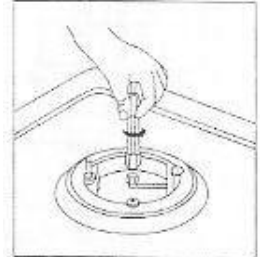

Setting the minimum level

- 1) Light the burner as already described.
- 2) Turn the tap to the minimum flame position.
- 3) Remove the control knobs.
- 4) **LPG TO NG:**

Use a thin blade screwdriver to turn the by-pass screw located above left of the gas valve, shaft as shown right. Turn gently the by-pass screw clockwise to the end completely then turn it anti-clockwise 1/2 turn for the Triple flame burner, 3/4 turn for the Large rapid burner, 1/2 turn for the Medium Semi-rapid Burner and 3/8 turn for the Auxiliary burner.

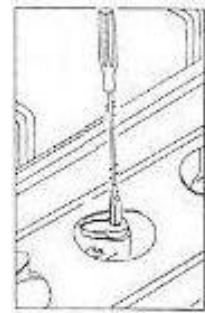

NG TO LPG:

Use a thin blade screwdriver to turn the by-pass screw located above left of the gas valve shaft as shown right. Turn gently the by-pass screw clockwise to the end.

- 5) Finally, check that the burner does not go out when the tap is turned quickly from the maximum to the minimum position.

Building into fitted kitchen units

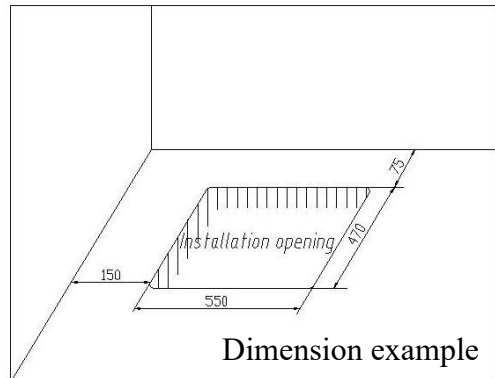
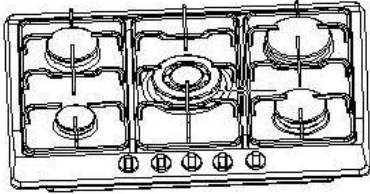

These hobs are designed for installation in fitted kitchen units up to 600mm deep with suitable characteristics.

Any cabinet side panels taller than the height of the hob itself must be at least 150mm away from the opening into which the hob is inserted.

The dimensions of the hob and the installation opening are shown in the illustration.

Insertion and fixing

Before inserting the hob in the installation opening, place the special gasket around the bottom edge of the hob.

It is important to fix this gasket evenly, without gaps or overlapping, to prevent liquid from **seeping underneath** the hob.

- 1) Remove the pan stands and the burner caps and turn the hob upside down, taking care not to damage the ignition plugs and the thermocouples.
- 2) Place the gasket around the bottom edge of the hob as shown in the illustration on the right.
- 3) Place the hob in the installation opening and push it down so that the hob is resting firmly on the cabinet, as show in the illustration. The side springs will hold it in place.

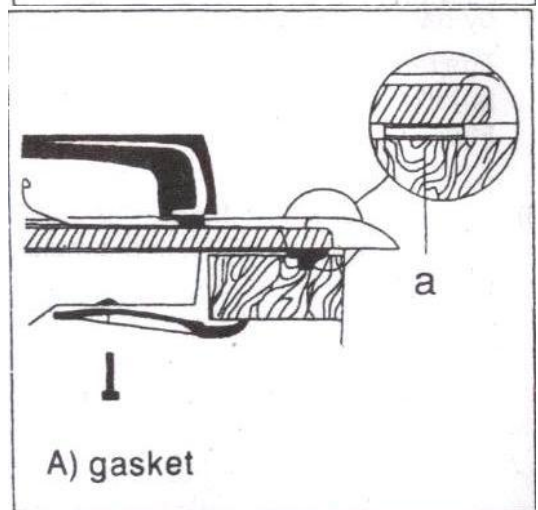
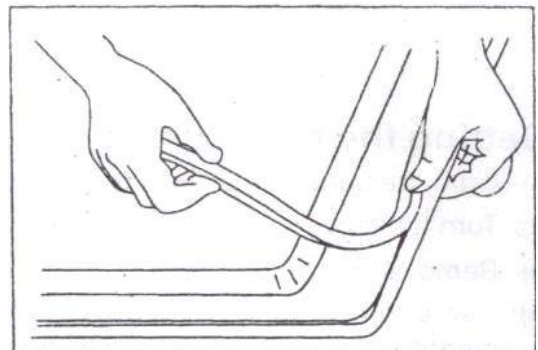

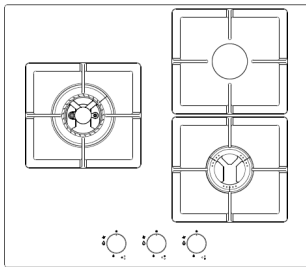

5GH65BB390

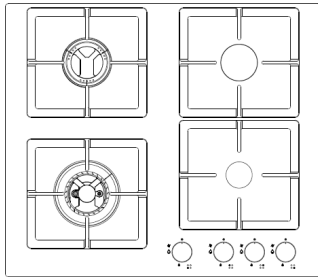

5GH65BB490

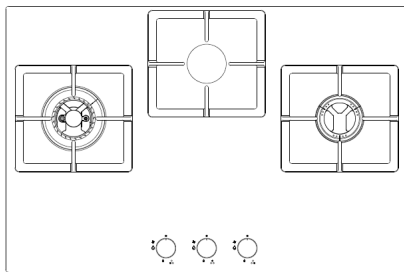

5GH75BB390

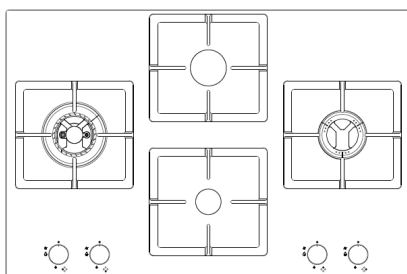

5GH75BB490

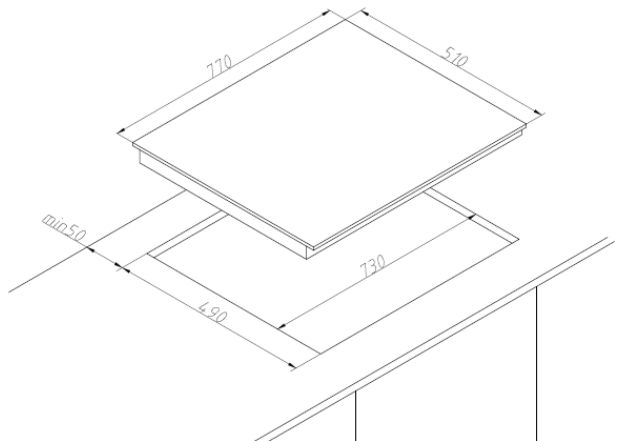
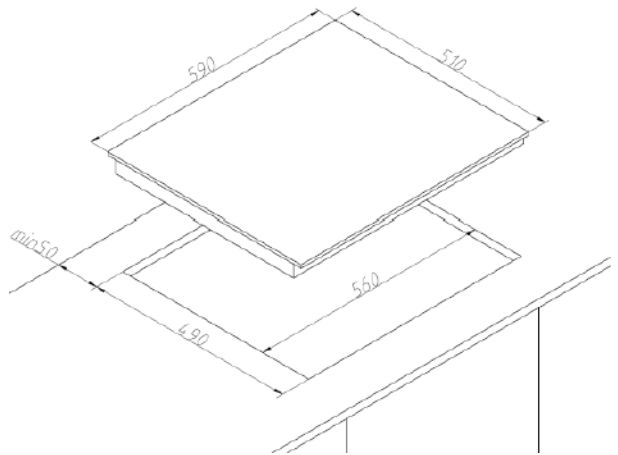

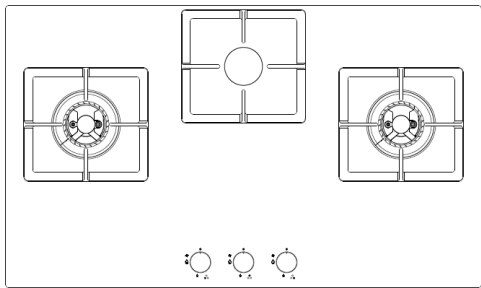

5GH85BB390

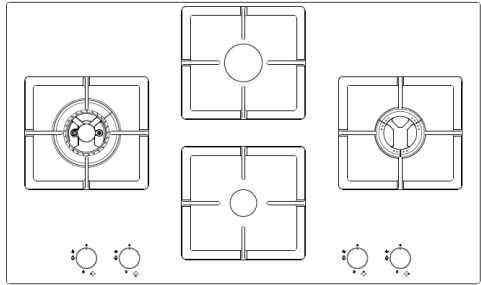

5GH85BB490

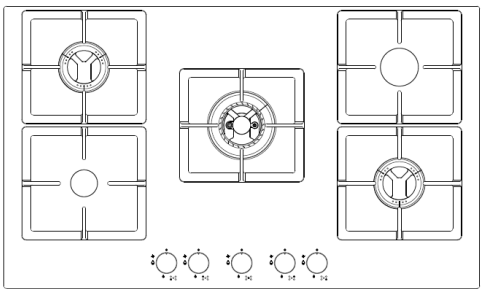

5GH85BB590

Service



www.blaupunkt-einbaugeraete.com

 **00 800 32 289 000**

Deutschland/Germany
service.DE@blaupunkt-einbaugeraete.com

Luxemburg/Luxembourg
service.LU@blaupunkt-einbaugeraete.com

Österreich/Austria
service.AT@blaupunkt-einbaugeraete.com

Schweiz/Switzerland
service.CH@blaupunkt-einbaugeraete.com

Niederlande/Netherlands
service.NL@blaupunkt-einbaugeraete.com

Italien/Italy
service.IT@blaupunkt-einbaugeraete.com

Belgien/Belgium
service.BE@blaupunkt-einbaugeraete.com

Spanien/Spain
service.ES@blaupunkt-einbaugeraete.com

Schweden/Sweden
service.SE@blaupunkt-einbaugeraete.com

Großbritannien/Great Britain
service.GB@blaupunkt-einbaugeraete.com

Frankreich/France
service.FR@blaupunkt-einbaugeraete.com

Malta/Malta
service.MT@blaupunkt-einbaugeraete.com

 **1800 252 878 658**

Australien/Australia
CustomerCare@blaupunktAU.com

 **1800 209 2096**

Indien/India
Customer_service@hepoindia.com