



## **Instructions for installation and use**

Extractor hood

**5IS66751/5IS69751/5IS66760/5IS69760**

## **Content**

Structure.....	1
Specification.....	1
Installation.....	2
Function Operation.....	5
Attentions.....	7
Maintenance.....	8
Common faults and solutions.....	9

## Foreword

Dear Customers,

Thank you for choosing our range hood. Please read the instruction manual carefully before using. It introduces the range hood's function, characters, installation, maintenance and etc. Please keep this manual with purchase invoice carefully for checking in the future.

(Pictures in the manual are for reference only. Please refer to thereal product)

## Structure

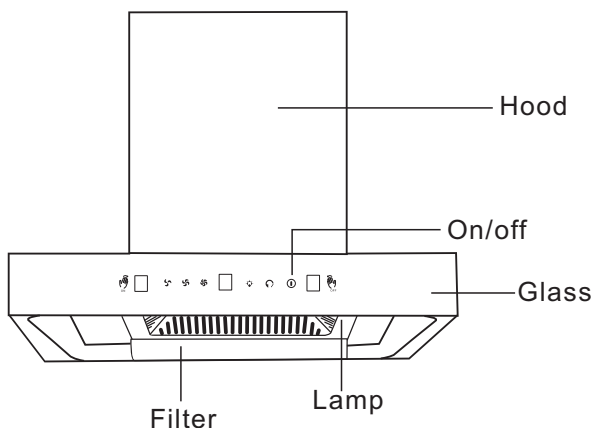

## Specification

Rated Voltage	230V
Rated Power Frequency	50Hz
Total Power	253W
Motor	Single

**Note: all specifications are subject to real product.**

## Installation

### 1. Installation

Please do not contact the steel and wires of wall inside in order to avoid electric shock.

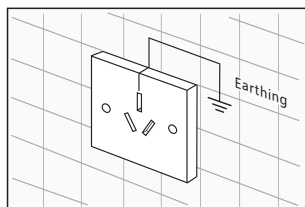

- The range hood must have earthing. It has a 3-pin plug. The plug must be connected to a socket with earthing. The earthing could offer an electricity circuit to avoid electric shock in case of electricity leakage.

- Please make sure the electricity supply system in your home (current, voltage, connecting wires) can meet the requirements of range hood's normal supply load.

- Please do not use high capacity fuse in electrical circuit and select the correct ones as required on rating label.

### 2. Preparation and confirmation before installation

- Wall strength

The wall that the range hood is placed must be hard enough to bear the weight of range hood.

- Height of mounting

The suitable height of mounting shall be 650-750mm above the cooking stove. The real installation height is subject to the construction of kitchen and user's height. The installation instruction of gas stove has given the suitable installation distance, please take it into consideration.

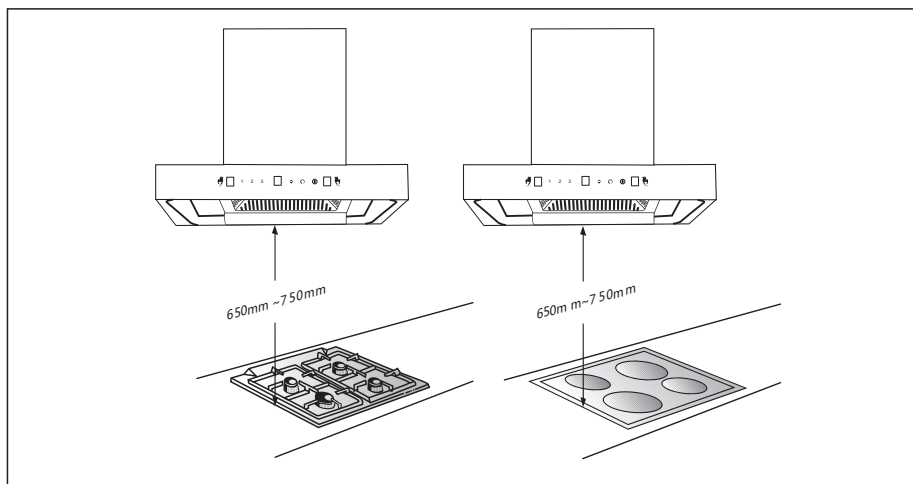

### 3. Installation hanger

Measure the installation height.  
Mark the position of hanger on the wall---Drill holes for fixing hanger---Punch plastic expansion bolts into the holes---Fix the hanger.

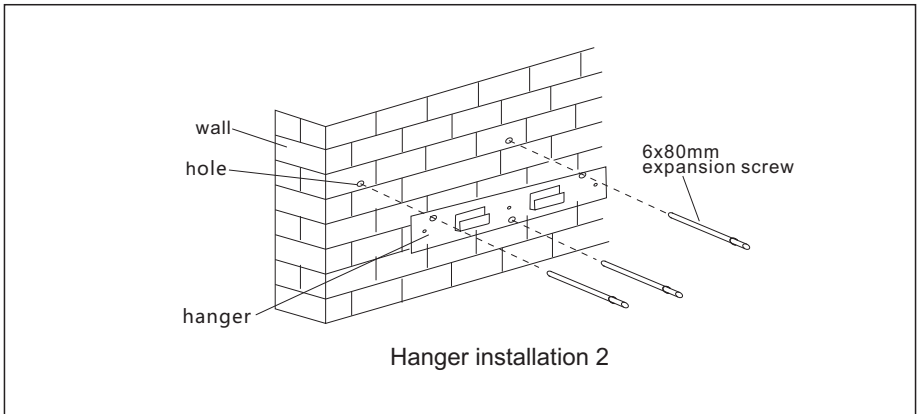
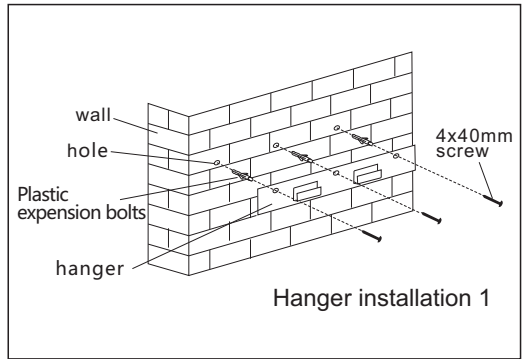

### 4. Product installation (single hood)

- Aim at the hanger and hang the range hood up on the wall.
- Connect the one end of exhaust pipe diameter 153mm to exhaust hole of range hood and the other end connect to air outlet.

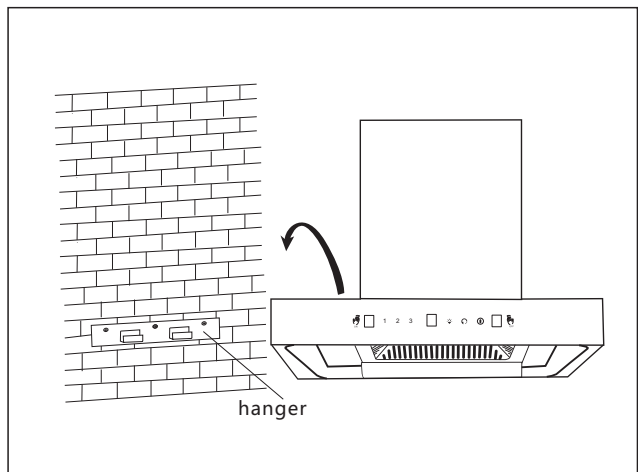

**Note: Make sure the range hood is hanging vertically and horizontally. Do not hang it on the tilt way.**

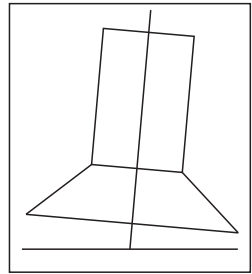
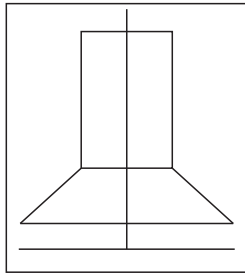

### 5.Product installation ( double hoods )

- Loose screws Aim at the hanger and hang the range hood on the wall---Pull the upper hood to the proper position---Mark the position of upper hood screw holes at upper side on the wall---Put upper hood back---Make the position of upper hanger side holes---Mark the position of two middle holes of upper hanger.
- Put down the range hood--- drill holes on markings--- insert plastic expansion bolts---fix upper hanger---install exhaust pipe on exhaust outlet---hang up the range hood--- connect the exhaust pipe to air outlet of kitchen ---pull the upper hood upwards and fix the side holes with screws.

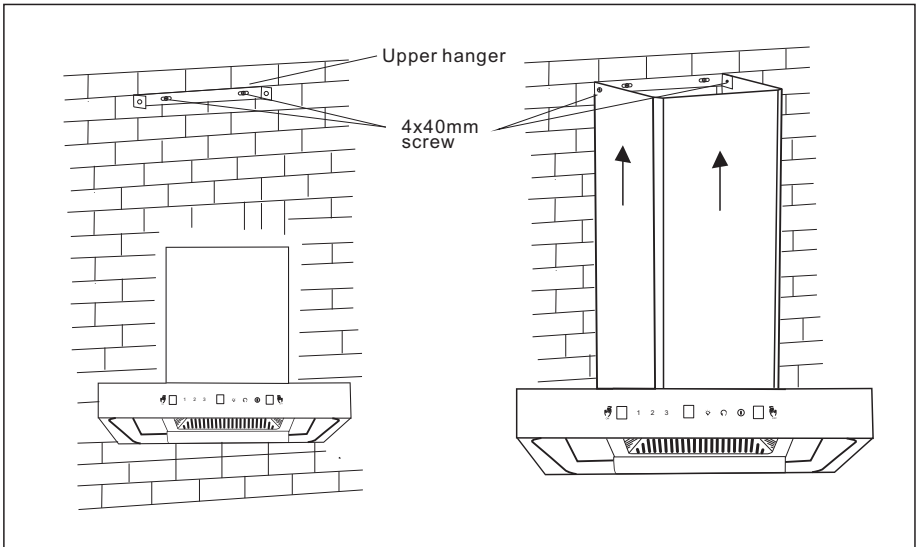

## 6. Exhaust pipe connecting to the wall outside

The other head of exhaust pipe shall be connected to the flue or the hole of wall outside (diameter of hole shall be 85mm) .

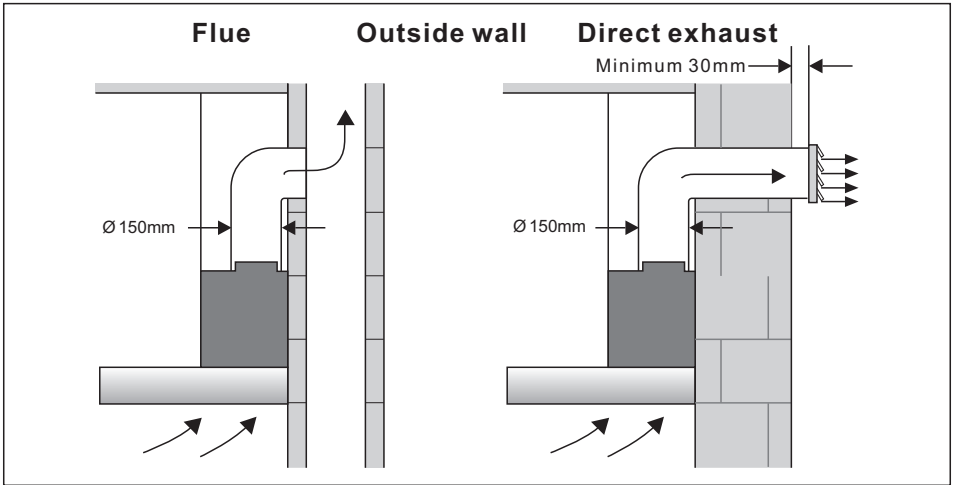

## 7. Confirmation of installation

After installation, connect to power supply and turn on the range hood. Check if all functions of range hood are working normally; no abnormal vibration and no resistance to leaves of air outlet.

### Function Operation

This cooker hood is operated with a gesture control and a feather touch control panel.

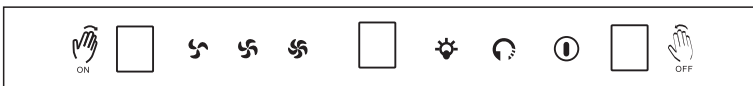

### Touch control:

- Place your finger on the “ⓘ” button, the lights on the control panel will come on and the cooker hood is now in stand-by mode.
- Place your finger one more time, the cooker hood will be turned off.
- Touch “↻” button, the cooker hood will start operating on LOW speed.
- Touch “⤵” button, the cooker hood will start operating on MEDIUM speed.
- Touch “⤴” button, the cooker hood will start operating on HIGH speed.
- Touch the “💡” button, the lights will turn on. Repeat this action, the lights will turn off.

- Touch the “🌀” button for 3 seconds. Wind wheel will run 9 minutes after heating working. Cleaning will be finished in 1 minute.
- Long touch the “🌀” button for 5 seconds in stand-by mode. The gesture control function will be locked. Repeat this action, it will be turned on.

### **Gesture control:**

Gesture control is the ability to recognize and interpret movements of the human body in order to interact with and control a PCB system without direct physical contact. Which can avoid poor touch caused by oil/grease on hand. Put your hand up in front of the sensor area, reasonable distance is: 50mm, then start to control cooker hood by hand gesture:

From left to right: the cooker hood will start operating on LOW speed, light will be turned on.

Repeat same gesture: the cooker hood will switch to MEDIUM speed and HIGH speed.

From right to left: the cooker hood will start operating on DELAY mode.

Repeat same gesture: the cooker hood will switch off.

### **Auto-Clean**

A unique “Auto-Clean” function has been provided in this cooker hood.

This cooker hood comes equipped with an oil collector tray. During cooking, the excess oil and dirt which gets sucked into the cooker hood gets drained into this oil collector.

However, over the time, some traces of stubborn grease and oil can get stuck inside the cooker hood.

In order to eliminate this stubborn grease and clean the cook hood from inside, we have designed this unique feature.

This new generation auto-clean function works with the help of specially designed heating element fixed within the hood.

Please make sure that the cooker hood is in stand-by model. Now touch the “Auto-Clean” button on the panel. A reverse timer of 10:00 minutes will get activated and the light for auto-clean will start blinking.

After the special heater has worked for 9 minutes, the fan will automatically start operating at low speed for the balance remaining 1 minute.

Most of the grease present within the cooker hood will get evaporated and blown out of the air-outlet. Any remaining grease will get drained out into the oil collector tray, located at the back of the filter.

The auto-clean function will stop operating at the end of 10 minutes.

Wait for a moment and then carefully remove the oil collector tray ensuring that you do not spill the grease.

Drain the collected grease into a sink and clean the oil collector tray with a soft cloth.



Fix the oil collector tray back at its place by sliding it in the rails at both the ends. Ensure that the tray is fixed properly.  
Your cooker hood is clean as new from inside now.

## **Delay**

A unique “Delay” shut –off function has been provided in this cooker hood. Once the cooking is over, instead of switching off the appliance, touch the “ON/OFF” button or put your hand up in front of the sensor area and move from right to left. A reverse timer of 3 minutes will get activated and the cooker hood will shut itself off after the end of this 3 minutes . If touch the “ON/OFF” button or move your hand from right to left twice, the cooker hood will be turned off at once.

## **Attention**

- Voltage and frequency must be complied with requirements of product. Supply socket must have reliable earthing.
- Make sure the installation of product is not connected to the steel and wires of wall inside in order to avoid electric shock.
- The wall must have sufficient strength to support the weight of range hood.
- Range hood shall be installed in horizontal level.
- The distance between exhaust hole and air outlet on the wall shall be less than 1.5m. When install the exhaust pipe, the air outlet shall not be too high to avoid oil flowing backwards.
- Range hood shall be used when gas or other fuels burning. The room must be well ventilated.
- Do not touch range hood directly. Gas burning without cooking or burning on the pan is forbidden.
- The air exhaust from range hood should not be exhausted to the flue of burning gas or other fuels.
- In case power cord is damaged, it shall be repaired by professional personnel or sent back to the appointed maintenance centre of our company for repair.
- Power supply must be cut off before changing lamps. New lamps must be the same specification as the current ones.

- Clean the oil on filter regularly. And clean the oil on wind wheel and volute or other components if necessary. If not follow the instruction in manual to clean range hood, it might cause fire hazard.
- Wear rubber gloves when clean range hood in order to prevent the injury of metal.
- It should be careful when clean the impeller to prevent deformation of impeller or rubbing off the counterweight, which might affect the balance, cause noise and vibration.
- It is strictly to prevent water seepage into switches, motor, lamps and other electric components when clean range hood.
- Non professional personnel are forbidden to change the internal wiring.

## Maintenance

### Maintenance

#### 1.Suggestion

- Clean the surface of shell every three days.
- Clean the oil on filter regularly.
- Full maintenance shall be done every half year. It should not be implemented by non professional personnel.

#### 2.When doing internal maintenance, the following steps shall be followed:

- Shut off power supply.
- Take off filter and cleaned by soft brush. Put it back in place after drying for next maintenance.
- Pull out smoke cover oblique upwards. Unscrew air inlet cover and air frame and take it off. Loosen the knob clockwise. Hold the wheel axle and pull out the impeller. Immerge the impeller into cleaning fluid around 10 minutes. Clean the oil on impeller with soft brush. Non professional personnel are not allowed to implement.
- Put impeller back in place. Tighten the knob counter clockwise. Then install air inlet board, air inlet cover and smoke cover in order.

**To keep the range hood working in good condition for long term, please keep maintenance regularly.**

## Common faults and solutions

If there are any abnormal phenomenon happened during range hood working, please stop using and unplug power supply and check the faults. Non professional personnel are not allowed to dismantle range hood. The common faults and diagnosis are as follow:

Fault	Reason	Solution
Lamp is not on Motor is running	Poor wire connect	Repair or change wires
	Lamp is damaged	Change lamp
	Poor connect between lamp and socket	Repair or change
	The quartz lamp transformer burning out	Change transformer
Lamp is not on Motor is not running	Poor connect between plug and socket	Repair or change
	Power cord break	Change power cord
	Fuse of power board breaks	Change fuse
Lamp is on Motor is not running	Thermal cutout of motor is working	Wait for a while and turn on again
	Condenser burns	Change condenser
	Motor burns	Change motor
	Faults of power board and control board	Contact maintenance center
Violent vibration, noise increases	Check the hanging is strong enough	Hanging range hood firmly
	The connecting pieces of the fixed screws are loose	Tighten screws
	Volute standing fixed screws are loose	Tighten screws
	Motor fixed screws are loose	Tighten screws
	Impeller installation is not in place	Install in place
	Impeller is damaged and balance piece is lost	Change impeller
Poor suction	Too much oil on filter	Clean filter
	The air convection in the kitchen is too big or space sealing is too tight	Reduce air convection and open doors and windows moderately
	Higher installation height	Adjust to appropriate height
	Exhaust pipe is too long or too more turns	Install according to the manual
	Outdoor wind is too strong	Non technical faults

## Service

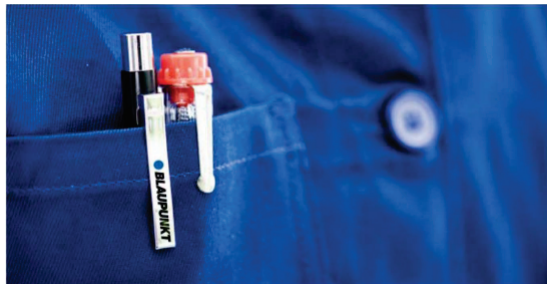

Blaupunkt integrated kitchen  
appliances/customer services:

Tel: 180 2092096

[customer\\_service@hepoindia.com](mailto:customer_service@hepoindia.com)

You have chosen a piece of premium kitchen equipment with Blaupunkt appliances. Our professional service is available to assist you after the purchase. Our qualified employees are pleased to remain at your disposal. Our customer service experts for Blaupunkt integrated kitchen appliances will professionally answer all questions about the appliances. Here you will receive all the information on handling, functions and performance.



Your direct route to Blaupunkt.  
[www.blaupunkt-einbaugeraete.com](http://www.blaupunkt-einbaugeraete.com)



### Convincing quality with Blaupunkt guarantee.

Blaupunkt kitchen appliances are exclusively produced from the best materials and according to the highest working standards. Blaupunkt provides a two-year manufacturer's guarantee on every appliance and every repair carried out by the Integrated kitchen appliances customer service.



### More original: Accessories and spare parts.

Original spare parts, extensive accessories and tested detergents and care products can be bought from our competent employees.



**In your vicinity - and fast. Our specialists from Blaupunkt.** With a nationwide service network and approximately 700 highly qualified technicians, we can guarantee that our specialists are always quickly on location in case of repair. The standard time is within 48 hours.